





# 1/2" JAC Junction Blocks

6 Port, 3 Pin JAC Junction blocks



Standard Wiring | MIN Receptacle | Cable | M23 Receptacle | 24 - 120 Volt | IP67 Rating

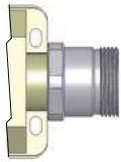
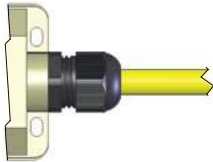

Trunk Style	Trunk Connection	No LED
	MIN Size II 8 Pole Male Receptacle	JAC-630-008-M000
	Yellow PVC AWM 20811 <b>8 x 18 AWG</b> 8.9mm OD	JAC-630-008-C**
	M23 12 Pole Male Receptacle	JAC-630-012-V**

\*\* Lengths in meters. Standard Cable lengths are 2m, 5m and 10m. Consult factory for other lengths.

JAC Junction Blocks

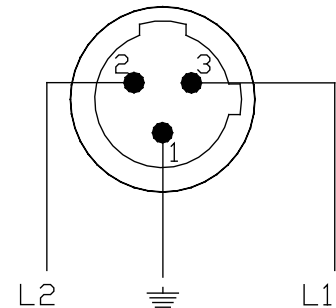
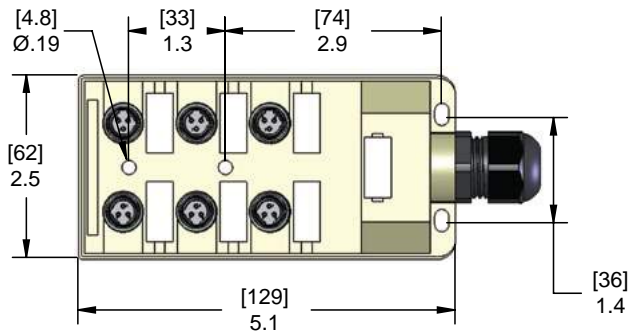

No LED Version

R

### Specifications:

- Ratings: 3 A per Connector  
8 A per Block
- Voltage: Without LEDs: 0-150 Volt Max  
With LEDs: 48 VDC Max in accordance with LED Configuration
- Body: Polypropylene
- Inserts: Polyamide
- Port Coupling Nuts: Nickel Plated Brass
- O-Ring: BUNA-N
- LED Lens: Polycarbonate
- Contacts: Copper Alloy with Gold Plating
- Marker Tags: Polyamide (supplied on all units)



# 1/2" JAC Junction Blocks

6 Port, 3 Pin JAC Junction blocks

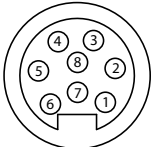
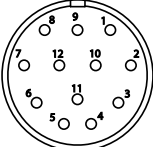

Standard Wiring | MIN Receptacle | Cable | M23 Receptacle | 24 - 120 Volt | IP67 Rating

Function	MIN-8MR Receptacle Version	12 Pin M23 Receptacle Version	Cable
	 <p>1"-16UN2</p>	 <p>M23 x 1</p>	Cable O.D. 0.35"
Ground	PIN #7	PIN #7	Green/Yellow
All PORTS PIN 3 (L1)	PIN #5	PIN #5	White
PORT 1 PIN 2 (L2)	PIN #6	PIN #6	Red
PORT 2 PIN 2 (L2)	PIN #1	PIN #1	Orange
PORT 3 PIN 2 (L2)	PIN #4	PIN #4	Black
PORT 4 PIN 2 (L2)	PIN #2	PIN #2	Blue
PORT 5 PIN 2 (L2)	PIN #3	PIN #3	White/Black
PORT 6 PIN 2 (L2)	PIN #8	PIN #8	Red/Black
Mating Plug	MIN-8FPX-*	MCV-12FP-**	

\* Length in feet. Standard Cable lengths are 3, 6, 12, 20, 30 & 50 feet. Consult factory for other lengths.

\*\* Lengths in meters. Standard Cable lengths are 1, 2, 4, 5, 6, 10 & 15 meters. Consult factory for other lengths.

JAC Junction Blocks

R